

A 编码

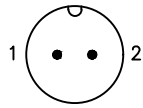

2Pin

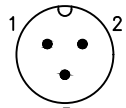

3Pin

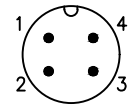

4Pin

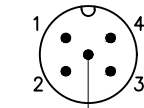

5Pin

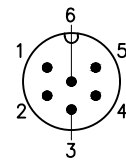

6Pin

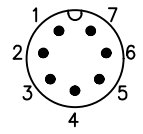

7Pin

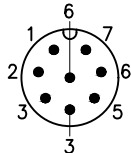

8Pin

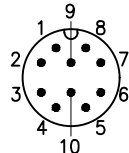

10Pin

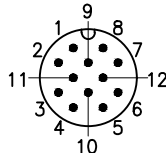

12Pin

B 编码

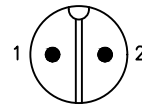

2Pin B

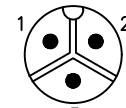

3Pin B

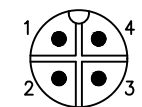

4Pin B

C 编码

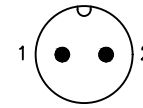

2Pin C

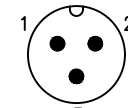

3Pin C

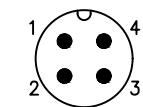

4Pin C

芯数	2P	3P	4P	5P	6P	7P	8P	10P	12P	2P B	3P B	4P B	2P C	3P C	4P C
额定电压	60V	60V	60V	60V	60V	60V	60V	30V	30V	300V	300V	300V	125V	125V	125V
额定电流	5A	5A	5A	5A	5A	5A	5A	2A	2A	10A	10A	10A	10A	10A	10A
防水等级	IP67/IP68														
使用温度	-45°C~105°C														

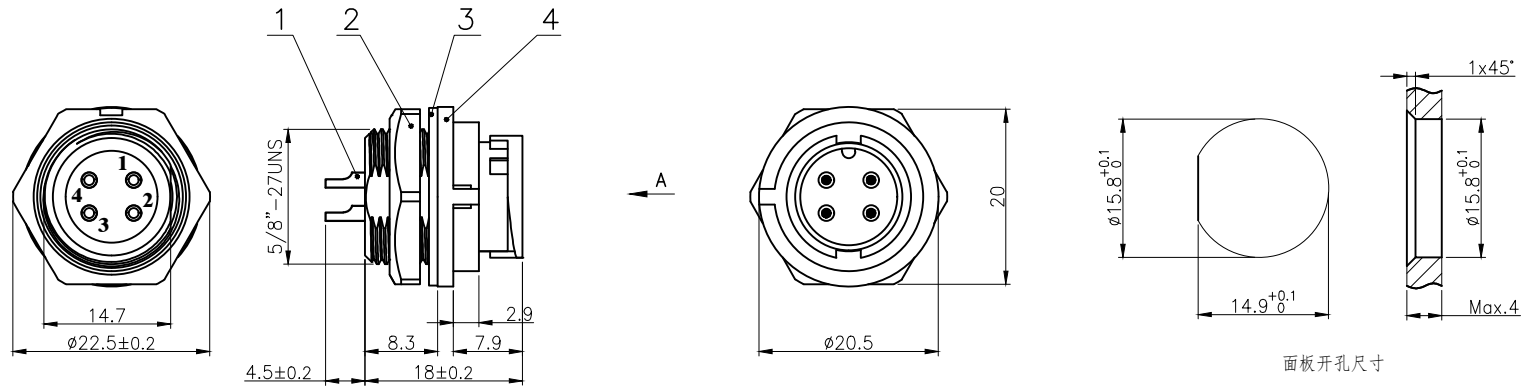

E系列 插针:

- 2~12P: E系列 1.0焊线式公针短针
- 2~4P B: E系列 1.6焊线式公针短针
- 2~4P C: E系列 1.6焊线式公针短针

4	E10 卡扣式板前针型插座外壳	尼龙	/	pc	1
3	E10 座子防水圈垫片 50° 硅橡胶 $\phi 20.3 \times \phi 15.4 - 1$	橡胶	/	pc	1
2	E10 塑料六角螺母 5/8"-27uns (22.5-20-3.6单边倒角)	尼龙	/	pc	1
1	E系列 焊线式公针短针	黄铜	镀金	pc	2~12
No.	Specification	Material	Treat	Unit	Q'ty

GENERAL TOLERANCE (UNLESS SPECIFIED)	DWN	DATE	
	L.L	2022.8.15	
	≤10 ±0.1	CHK	DATE
<10~≤20 ±0.2	APVD	DATE	TITLE
<20~≤50 ±0.5			E10 卡扣式板前针型插座
Angle ±1°	UNIT	REV	PART NO
	MM	A	
THIRD ANGLE	SIZE	SHEET	DRAWING NO
	A4	1 OF 1	E10P-BB-Px