

Rev.	Change Description	ECN #	Date

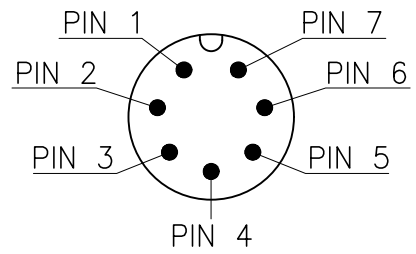

VIEW A

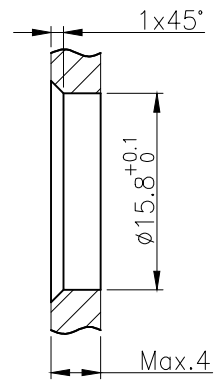
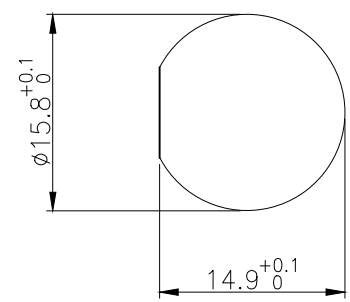
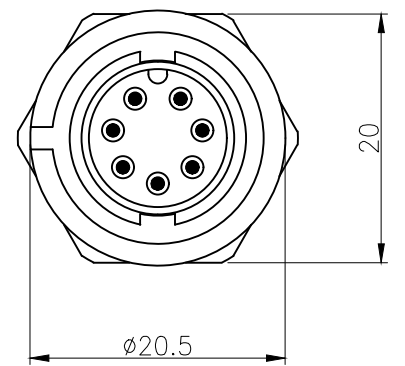
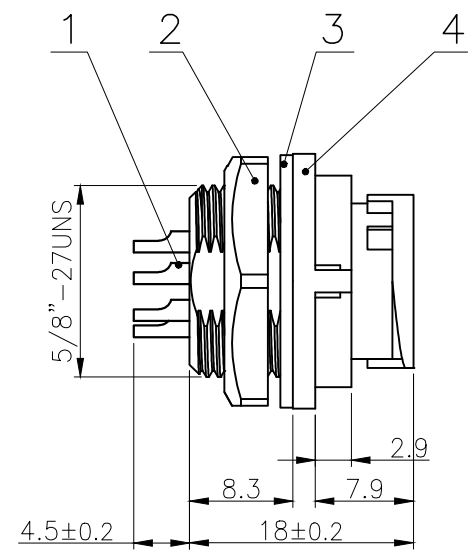
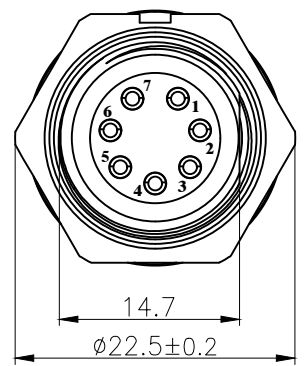

BOARD END HOLE
OPENING SIZE

4	E10 Card buckle type panel front needle type socket shell (7 core)	Nylon	/	pc	1
3	E10 Waterproof sealing gasket $\phi 20.3 \times \phi 15.4-1$	NBR	/	pc	1
2	E10 Plastic hexagon nut 5/8"-27uns	Nylon	/	pc	1
1	E Type Male contact pin	Brass	Gold pated	pc	7
No.	Specification	Material	Treat	Unit	Q'ty

Technical specifications:		Materials:	
Coupling:	Card buckle connection	Shell material:	PA66+GF UL94 black
Termination:	Soldering	Contact material:	Brass Gold plated
Pollution degree:	3	Insert material:	PA66+GF UL94 black
Temperature range:	-45°C ~ +105°C	Sealing:	NBR
Degree of protection:	IP67		
Mating cycles:	≥500		
Rated voltage:	60V AC/DC		
Rated current:	5A		
All s are RoHS compliant			

GENERAL TOLERANCE (UNLESS SPECIFIED)	DWN	DATE	
	LL	2022.8.15	
	CHK	DATE	
≤10 ±0.1	APVD	DATE	TITLE E10 Male Front Mount Solder Receptacle 7 core
<10~≤20 ±0.2			
<20~≤50 ±0.5			
Angle ±1°			
 THIRD ANGLE	UNIT	REV	PART NO
	MM	A	E10022-07A000000
	SIZE	SHEET	DRAWING NO
A4	1 OF 1	E10P-BB-P7	