

A 编码

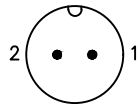

2Pin

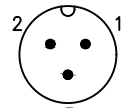

3Pin

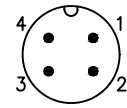

4Pin

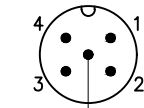

5Pin

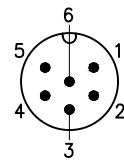

6Pin

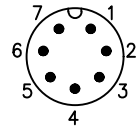

7Pin

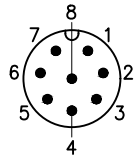

8Pin

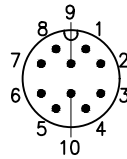

10Pin

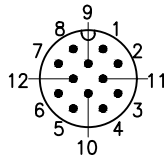

12Pin

B 编码

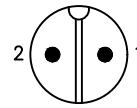

2Pin B

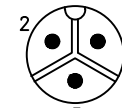

3Pin B

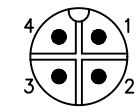

4Pin B

C 编码

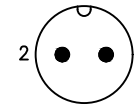

2Pin C

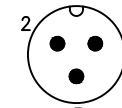

3Pin C

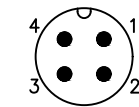

4Pin C

芯数	2P	3P	4P	5P	6P	7P	8P	10P	12P	2P B	3P B	4P B	2P C	3P C	4P C
额定电压	60V	60V	60V	60V	60V	60V	60V	30V	30V	300V	300V	300V	125V	125V	125V
额定电流	5A	5A	5A	5A	5A	5A	5A	2A	2A	10A	10A	10A	10A	10A	10A
防水等级	IP67/IP68														
使用温度	-45°C~105°C														

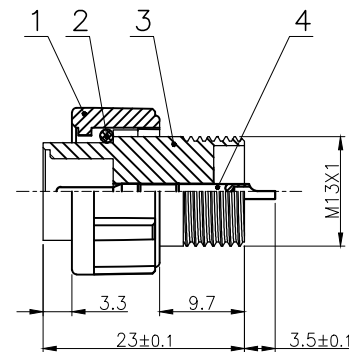
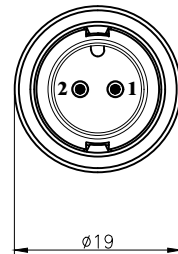

E系列 插针:

2~12P: E系列 1.0焊线式公针长针

2~4P B: E系列 1.6焊线式公针长针

2~4P C: E系列 1.6焊线式公针长针

4	E系列 焊线式公针长针	黄铜	镀金	pc	1
3	E10 针型插头外壳	尼龙	/	pc	1
2	E10 插头胶芯0型防水圈 Φ12×Φ9×1.5	橡胶	/	pc	2~12
1	E10 卡扣式连接螺帽	尼龙	/	pc	1
No.	Specification	Material	Treat	Unit	Q'ty

GENERAL TOLERANCE
(UNLESS SPECIFIED)

≤10 ±0.1

<10~≤20 ±0.2

<20~≤50 ±0.5

Angle ±1°

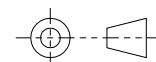

THIRD ANGLE

DWN

L.L

DATE

2022.8.15

CHK

DATE

APVD

DATE

UNIT

MM

REV

A

SIZE

A4

SHEET

1 OF 1

CAZN 正成

TITLE

E10 卡扣式针型插头半成品

PART NO

DRAWING NO

E10P-BA-Px