

Rev.	Change Description	ECN #	Date

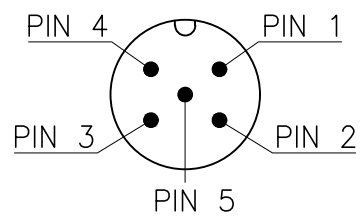
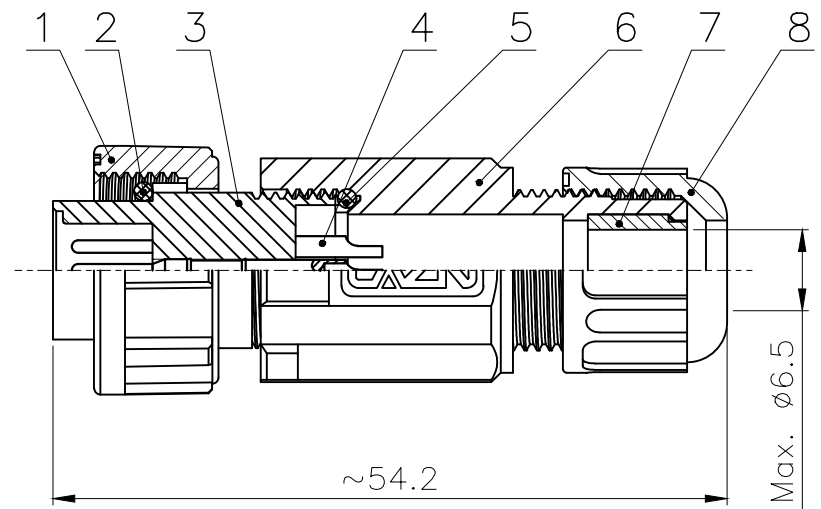
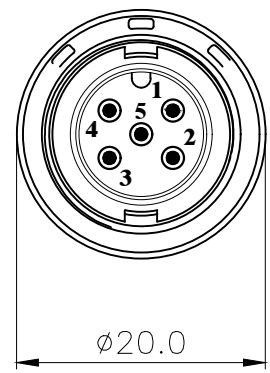

VIEW A

No.	Specification	Material	Treat	Unit	Q'ty
8	Line lock nut	Nylon	/	pc	1
7	Assembled waterproof rubber plug	silica gel	/	pc	1
6	E10 Plug type body	Nylon	/	pc	1
5	Waterproof sealing O-rind	NBR	/	pc	1
4	E type Male contact pin	Brass	Gold plated	pc	5
3	E10 Needle type socket shell (5 core)	Nylon	/	pc	1
2	E10 Insulator O ring $\phi 12 \times \phi 9 \times 1.5$	NBR	/	pc	1
1	E10 Thread type Connecting nut	Nylon	/	pc	1

Technical specifications:		Materials:	
Coupling:	Threaded connection	Shell material:	PA66+GF UL94 black
Termination:	Soldering	Contact material:	Brass Gold plated
Pollution degree:	3	Insert material:	PA66+GF UL94 black
Temperature range:	-45°C ~ +105°C	Sealing:	NBR
Degree of protection:	IP67		
Mating cycles:	≥500		
Rated voltage:	60V AC/DC		
Rated current:	5A		

All parts are RoHS compliant

GENERAL TOLERANCE (UNLESS SPECIFIED)	DWN	DATE	
	LL	2022.8.15	
	CHK	DATE	
≤10 ±0.1	APVD	DATE	TITLE E10 Straight Male Field Installable Plug (5 core)
<10~≤20 ±0.2			PART NO E10009-05A000000
<20~≤50 ±0.5			DRAWING NO E10P-TA1-P5
Angle ±1°	UNIT	REV	
	MM	A	
	SIZE	SHEET	
	A4	1 OF 1	

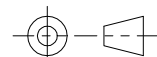

THIRD ANGLE