

A 编码

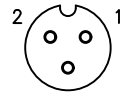

2Pin



3Pin

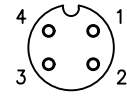

4Pin

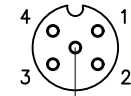

5Pin

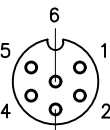

6Pin

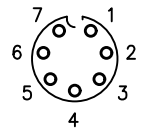

7Pin

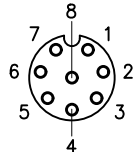

8Pin

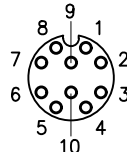

10Pin

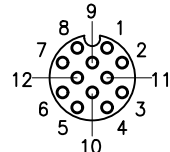

12Pin

B 编码



2Pin B

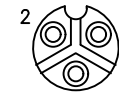

3Pin B

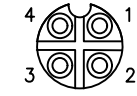

4Pin B

C 编码

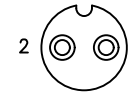

2Pin C

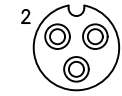

3Pin C

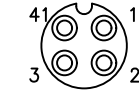

4Pin C

芯数	2P	3P	4P	5P	6P	7P	8P	10P	12P	2P B	3P B	4P B	2P C	3P C	4P C
额定电压	60V	60V	60V	60V	60V	60V	60V	30V	30V	300V	300V	300V	125V	125V	125V
额定电流	5A	5A	5A	5A	5A	5A	5A	2A	2A	10A	10A	10A	10A	10A	10A
防水等级	IP67/IP68														
使用温度	-45°C~105°C														

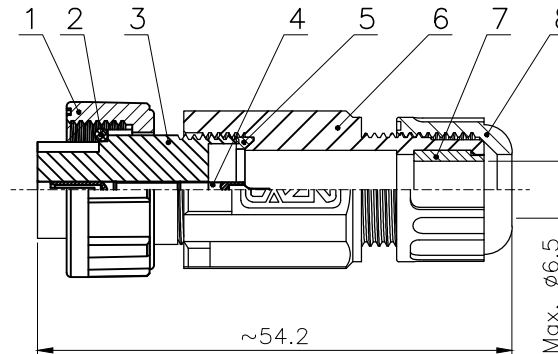
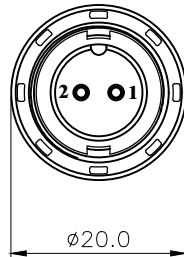

E系列 插针:

2~12P: E系列 1.0焊线式母针长针

2~4P B: E系列 1.6焊线式母针长针

2~4P C: E系列 1.6焊线式母针长针

8	E10 紧锁螺帽	尼龙	/	pc	1
7	E10 组装式防水硅胶塞	硅胶	/	pc	1
6	E10 插头主体	尼龙	/	pc	1
5	E10 组装式主体防水垫片 $\Phi 12 \times \Phi 9.3-2$	橡胶	/	pc	1
4	E系列 焊线式母针长针	黄铜	镀金	pc	1
3	E10 孔型插头外壳	尼龙	/	pc	1
2	E10 插头胶芯O型防水圈 $\Phi 12 \times \Phi 9 \times 1.5$	橡胶	/	pc	2~12
1	E10 螺纹式连接螺帽	尼龙	/	pc	1
No.	Specification	Material	Treat	Unit	Q'ty

GENERAL TOLERANCE
(UNLESS SPECIFIED)

≤10 ±0.1

<10~≤20 ±0.2

<20~≤50 ±0.5

Angle ±1°

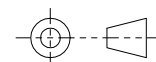

THIRD ANGLE

DWN DATE

L.L. 2022.8.15

CHK DATE

APVD DATE

UNIT REV

MM A

SIZE SHEET

A4 1 OF 1

TITLE
E10 螺纹式孔型组装式插头

PART NO

DRAWING NO

E10P-TA1-Sx