

A 编码

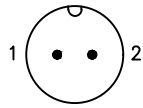

2Pin

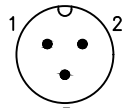

3Pin

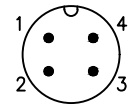

4Pin

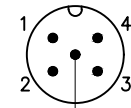

5Pin

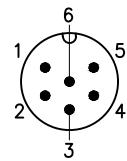

6Pin

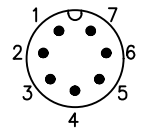

7Pin

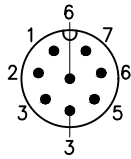

8Pin

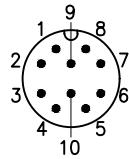

10Pin

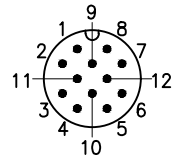

12Pin

B 编码

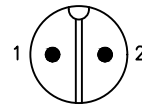

2Pin B

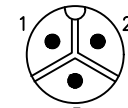

3Pin B

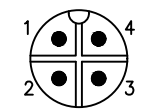

4Pin B

C 编码

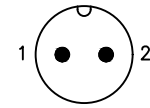

2Pin C

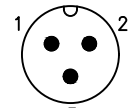

3Pin C

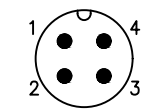

4Pin C

芯数

2P

3P

4P

5P

6P

7P

8P

10P

12P

2P B

3P B

4P B

2P C

3P C

4P C

额定电压

60V

60V

60V

60V

60V

60V

60V

30V

30V

300V

300V

300V

125V

125V

125V

额定电流

5A

5A

5A

5A

5A

5A

5A

2A

2A

10A

10A

10A

10A

10A

10A

防水等级

IP67/IP68

使用温度

-45°C~105°C

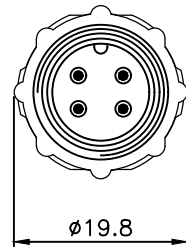

ø19.8

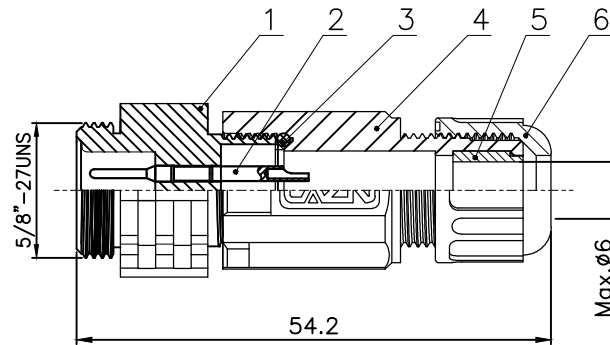

E系列 插针:

2~12P: E系列 1.0焊线式公针长针

2~4P B: E系列 1.6焊线式公针长针

2~4P C: E系列 1.6焊线式公针长针

6	E10 紧锁螺帽	尼龙	/	pc	1
5	E10 组装式防水硅胶塞	硅胶	/	pc	1
4	E10 插头主体	尼龙	/	pc	1
3	防水O型圈 φ13Xφ10X1.5	橡胶	/	pc	1
2	E系列 焊线式公针长针	黄铜	镀金	pc	2~12
1	E10 螺纹式针型对接插头外壳	尼龙	/	pc	1
No.	Specification	Material	Treat	Unit	Q'ty

GENERAL TOLERANCE
(UNLESS SPECIFIED)

≤10 ±0.1

<10~≤20 ±0.2

<20~≤50 ±0.5

Angle ±1°

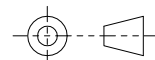

THIRD ANGLE

DWN

CHK

APVD

UNIT

MM

SIZE

A4

REV

A

SHEET

1 OF 1

TITLE

E10 螺纹式针型对接组装式插头

PART NO

DRAWING NO

E10P-TK1-Px