

Rev.	Change Description	ECN #	Date

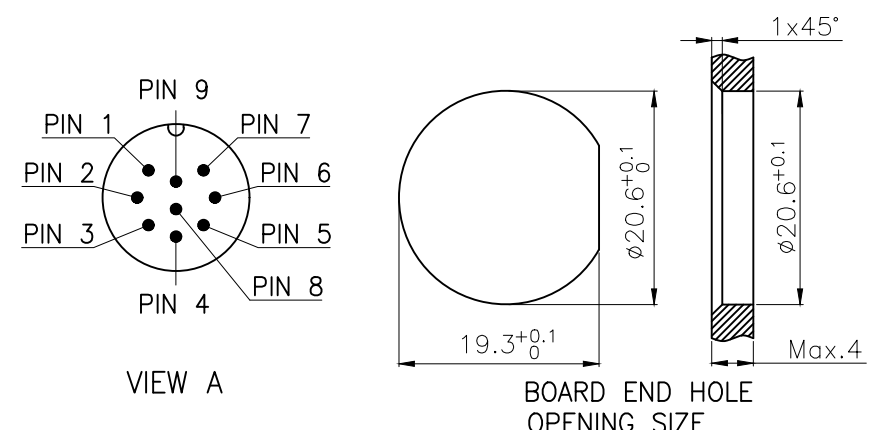
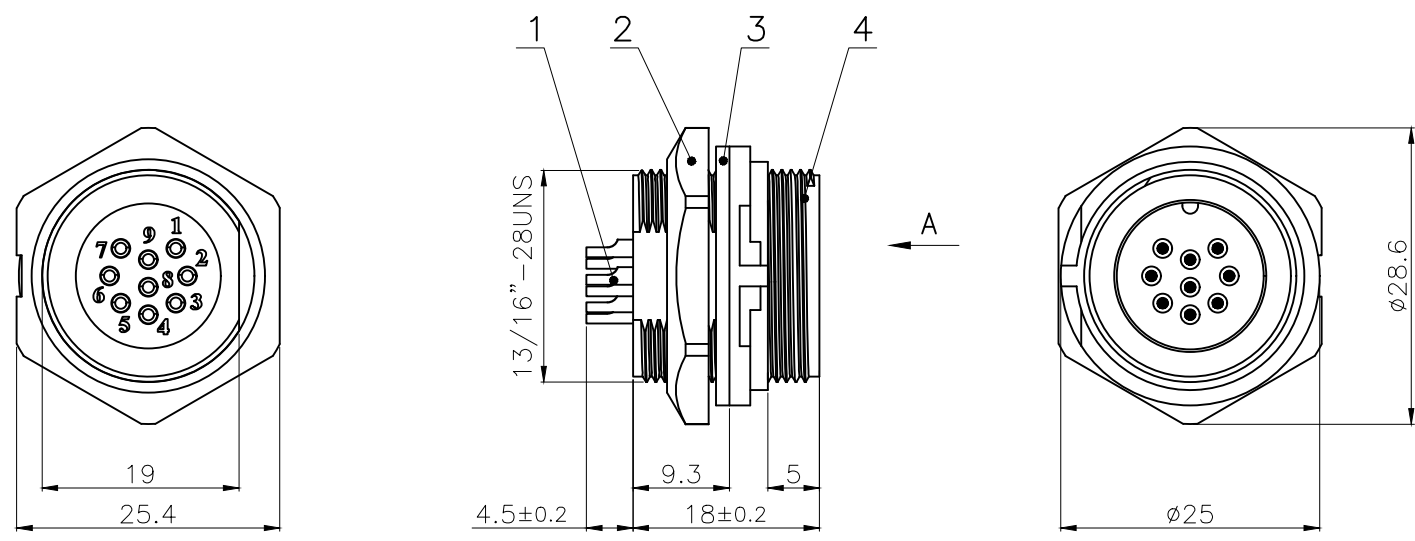

No.	Specification	Material	Treat	Unit	Q'ty
4	E13 panel front male socket shell (9 core)	Nylon	/	pc	1
3	E13 Waterproof sealing gasket	silica gel	/	pc	1
2	E13 Plastic hexagon nut	Nylon	/	pc	1
1	Male contact pin	Brass	Gold pated	pc	9

Technical specifications:		Materials:	
Coupling:	Card buckle connection	Shell material:	PA66+GF UL94 black
Termination:	Soldering	Contact material:	Brass Gold plated
Pollution degree:	3	Insert material:	PA66+GF UL94 black
Temperature range:	-45°C ~ +105°C	Sealing:	NBR
Degree of protection:	IP67		
Mating cycles:	≥500		
Rated voltage:	60V AC/DC		
Rated current:	5A		

GENERAL TOLERANCE (UNLESS SPECIFIED)	DWN	DATE	CAZN 正成
	L.L	2022.11.12	
	CHK	DATE	
≤10 ±0.1	APVD	DATE	TITLE
<10~≤20 ±0.2			
<20~≤50 ±0.5			
Angle ±1°			
 THIRD ANGLE	UNIT	REV	PART NO
	MM	A	E13022-09A000000
	SIZE	SHEET	DRAWING NO
A4	1 OF 1	E13P-BB-P9	

All parts are RoHS compliant