

Rev.	Change Description	ECN #	Date

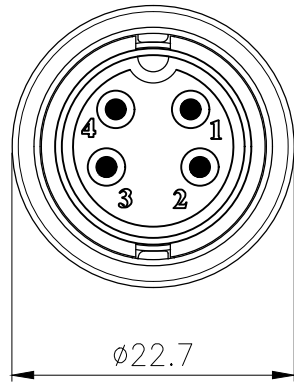

A →

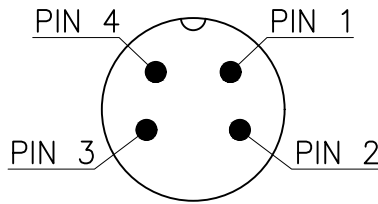
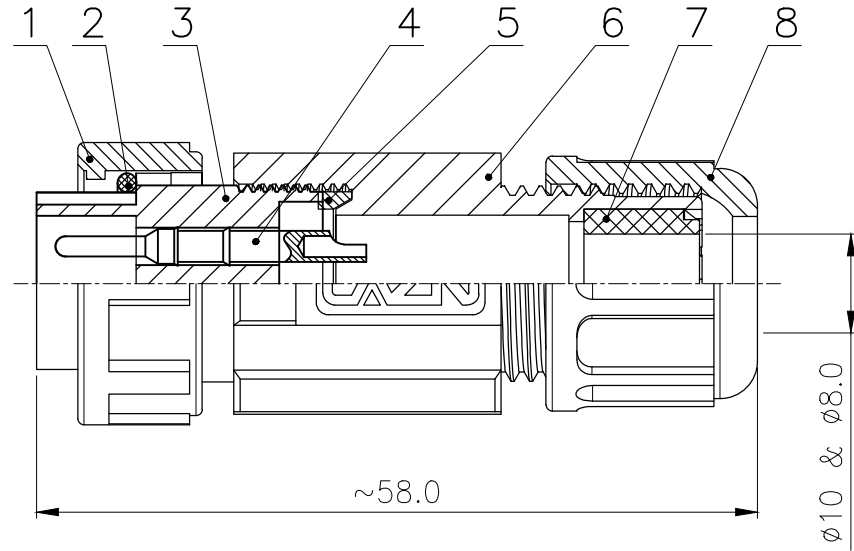

VIEW A

No.	Specification	Material	Treat	Unit	Q'ty
8	Line lock nut	Nylon	/	pc	1
7	Assembled waterproof rubber plug	silica gel	/	pc	1
6	E13 Plug type body	Nylon	/	pc	1
5	E13 Assembly type body waterproof gasket	NBR	/	pc	1
4	Male contact pin	Brass	Gold pated	pc	4
3	E13 Needle type socket shell (4 croe)	Nylon	/	pc	1
2	E13 Insulator O ring $\phi 14 \times \phi 11 \times 1.5$	NBR	/	pc	1
1	E13 Card buckle type Connecting nut	Nylon	/	pc	1

Technical specifications:		Materials:	
Coupling:	Card buckle connection	Shell material:	PA66+GF UL94 black
Termination:	Soldering	Contact material:	Brass Gold plated
Pollution degree:	3	Insert material:	PA66+GF UL94 black
Temperature range:	-45°C ~ +105°C	Sealing:	NBR
Degree of protection:	IP67		
Mating cycles:	≥500		
Rated voltage:	125V AC/DC		
Rated current:	10A		

All s are RoHS compliant

GENERAL TOLERANCE (UNLESS SPECIFIED) $\leq 10 \pm 0.1$ $< 10 \sim \leq 20 \pm 0.2$ $< 20 \sim \leq 50 \pm 0.5$ Angle $\pm 1^\circ$	DWN	DATE	
	L.L	2022.11.12	
	CHK	DATE	
	APVD	DATE	TITLE
 THIRD ANGLE	UNIT	REV	PART NO
	MM	A	E13009-04A000000
	SIZE	SHEET	DRAWING NO
	A4	1 OF 1	E13P-BA1-P4