

A 编码

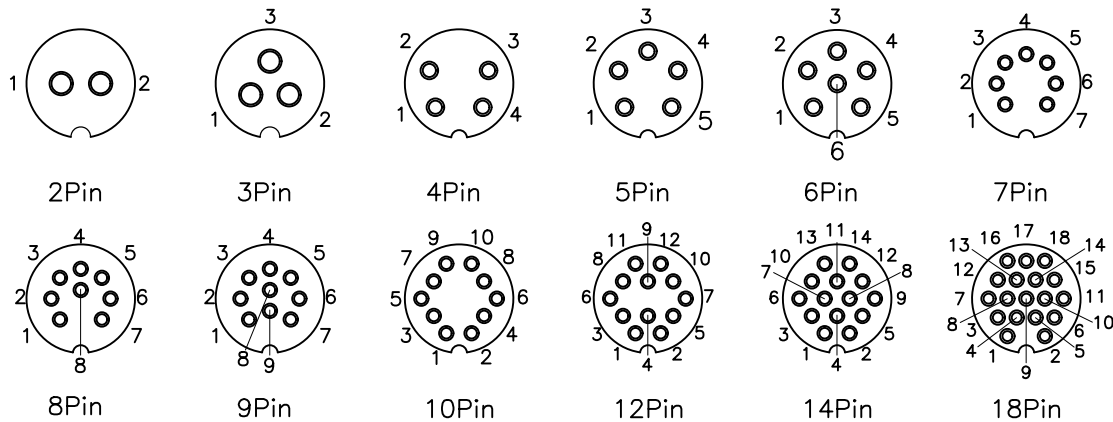

B 编码

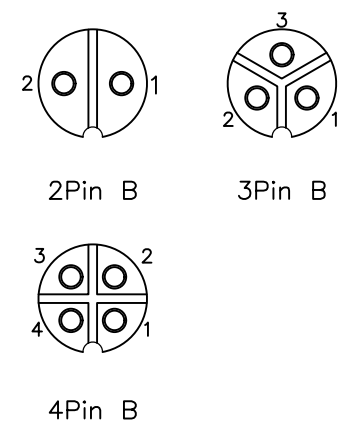

C 编码

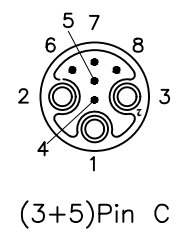

芯数	2P	3P	4P	5P	6P	7P	8P	9P	10P	12P	14P	18P	2P B	3P B	4P B	8P B
额定电压	125V	125V	125V	125V	125V	60V	60V	60V	60V	60V	60V	30V	300V	300V	300V	125+30V
额定电流	20A	20A	10A	10A	10A	5A	5A	5A	5A	5A	5A	2A	20A	20A	20A	15+2A
防水等级	IP67/IP68															
使用温度	-45°C~105°C															

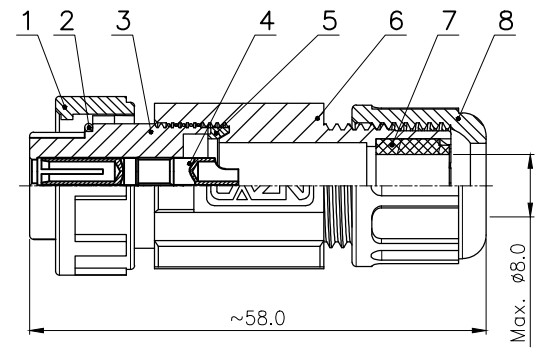
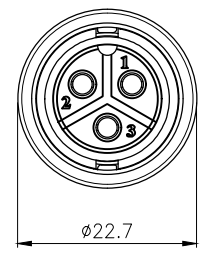

8	E13 紧锁螺帽	1
7	E13 组装式防水硅胶塞 70° 硅橡胶	1
6	E13 插头主体	1
5	E13 组装式主体防水垫片 70° 硅橡胶(橙色) $\phi 14.8 \times \phi 12-2.7$	1
4	E系列 焊线式母针长针	2~18
3	E13 孔型插头外壳	1
2	E13 插头胶芯O型防水圈 70° 硅橡胶(红色) $\phi 14 \times \phi 11 \times 1.5$	1
1	E13 卡扣式连接螺帽	1
序号 (No.)	名称 (Name)	数量 (Qty)

GENERAL TOLERANCE (UNLESS SPECIFIED)	DWN		
	CHK		
APVD	TITLE E13 卡扣式孔型组装式插头		
THIRD ANGLE	UNIT MM	REV A	PART NO
	SIZE A4	SHEET 1 OF 1	DRAWING NO E13P-BA1-Sx