

Rev.	Change Description	ECN #	Date

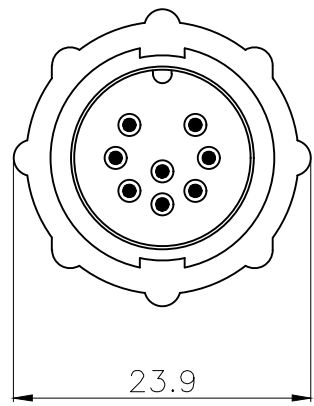

A →

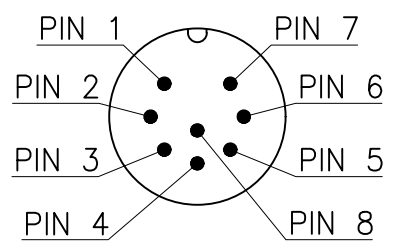
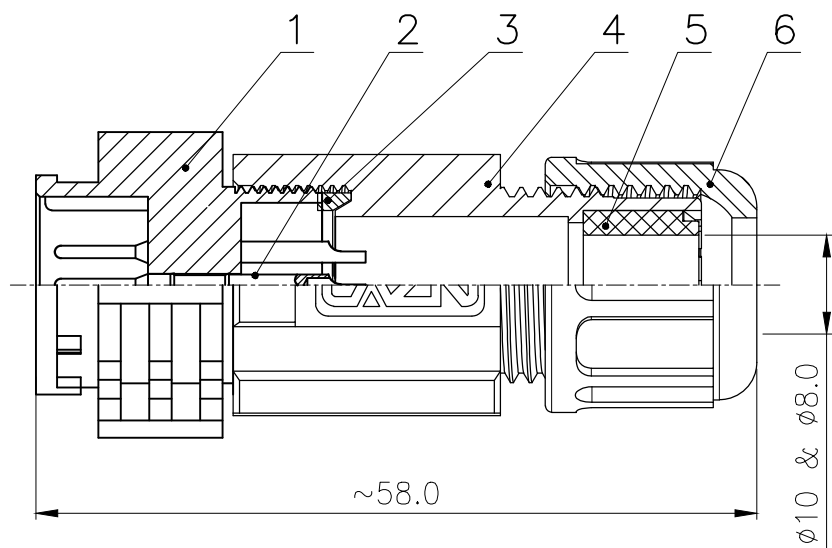

VIEW A

No.	Specification	Material	Treat	Unit	Q'ty
6	Line lock nut	Nylon	/	pc	1
5	Assembled waterproof rubber plug	silica gel	/	pc	1
4	E13 Plug type body	Nylon	/	pc	1
3	E13 Assembly type body waterproof gasket	NBR	/	pc	1
2	Male contact pin	Brass	Gold plated	pc	8
1	E13 Card buckle needle type docking plug housing (8 core)	Nylon	/	pc	1

Technical specifications:		Materials:	
Coupling:	Card buckle connection	Shell material:	PA66+GF UL94 black
Termination:	Soldering	Contact material:	Brass Gold plated
Pollution degree:	3	Insert material:	PA66+GF UL94 black
Temperature range:	-45°C ~ +105°C	Sealing:	NBR
Degree of protection:	IP67		
Mating cycles:	≥500		
Rated voltage:	60V AC/DC		
Rated current:	5A		

All parts are RoHS compliant

GENERAL TOLERANCE (UNLESS SPECIFIED)	≤10	±0.1	DWN L.L	DATE	2022.11.12	
	<10~≤20	±0.2		CHK	DATE	
	<20~≤50	±0.5	APVD	DATE	TITLE	
 THIRD ANGLE	UNIT	MM	REV	A	PART NO	E13020-08A000000
	SIZE	A4	SHEET	1 OF 1	DRAWING NO	E13P-BK1-P8