

Rev.	Change Description	ECN #	Date

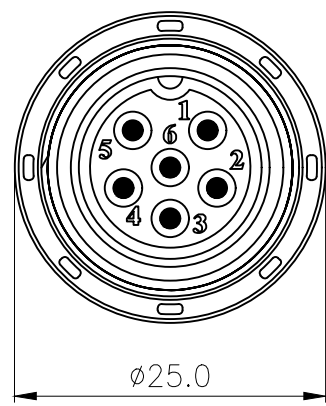

A →

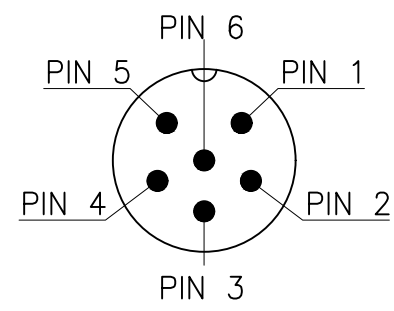
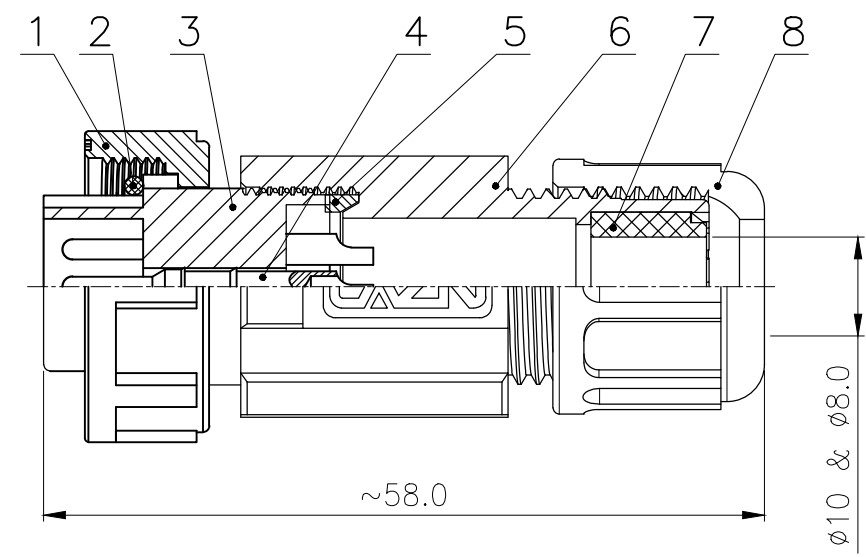

VIEW A

No.	Specification	Material	Treat	Unit	Q'ty
8	Line lock nut	Nylon	/	pc	1
7	Assembled waterproof rubber plug	silica gel	/	pc	1
6	E13 Plug type body	Nylon	/	pc	1
5	E13 Assembly type body waterproof gasket	NBR	/	pc	1
4	Male contact pin	Brass	Gold pated	pc	6
3	E13 Needle type socket shell (6 croe)	Nylon	/	pc	1
2	E13 Insulator O ring $\phi 14 \times \phi 11 \times 1.5$	NBR	/	pc	1
1	E13 Thread type Connecting nut	Nylon	/	pc	1

Technical specifications:		Materials:	
Coupling:	Threaded connection	Shell material:	PA66+GF UL94 black
Termination:	Soldering	Contact material:	Brass Gold plated
Pollution degree:	3	Insert material:	PA66+GF UL94 black
Temperature range:	-45°C ~ +105°C	Sealing:	NBR
Degree of protection:	IP67		
Mating cycles:	≥500		
Rated voltage:	125V AC/DC		
Rated current:	10A		

All s are RoHS compliant

GENERAL TOLERANCE (UNLESS SPECIFIED)	DWN	DATE
	L.L	2022.11.12
	CHK	DATE
≤10 ±0.1 <10~≤20 ±0.2 <20~≤50 ±0.5 Angle ±1°	APVD	DATE
	UNIT	REV
 THIRD ANGLE	MM	A
	SIZE	SHEET
	A4	1 OF 1



TITLE	
PART NO	E13009-06A000000
DRAWING NO	E13P-TA1-P6