

| Rev. | Change Description | ECN # | Date |
|------|--------------------|-------|------|
| | | | |

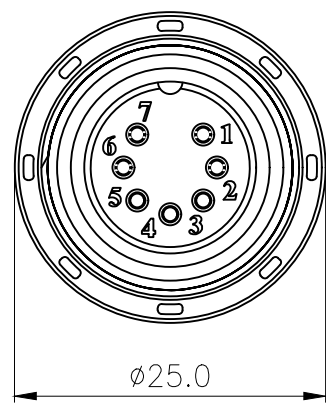

A →

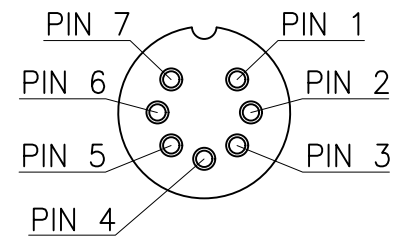
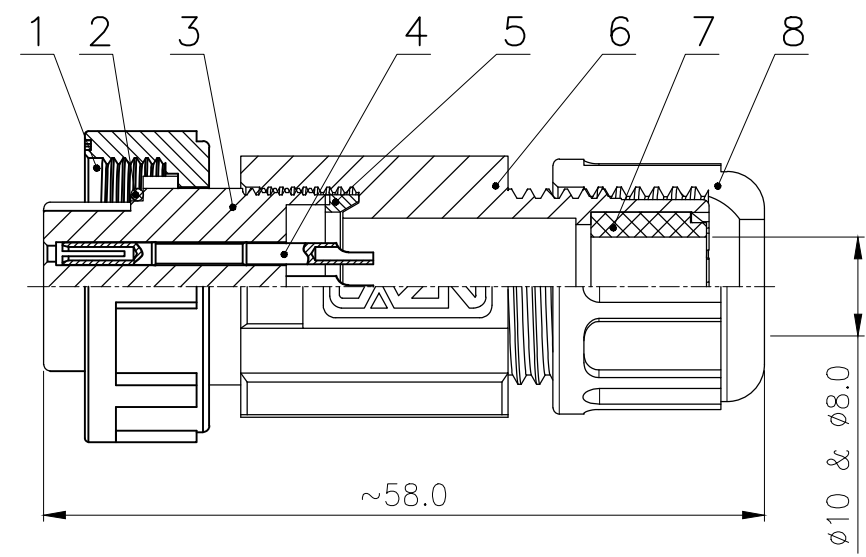

VIEW A

| No. | Specification | Material | Treat | Unit | Q'ty |
|-----|--|-----------------|------------|------|------|
| 8 | Line lock nut | Nylon | / | pc | 1 |
| 7 | Assembled waterproof rubber plug | silica gel | / | pc | 1 |
| 6 | E13 Plug type body | Nylon | / | pc | 1 |
| 5 | E13 Assembly type body waterproof gasket | NBR | / | pc | 1 |
| 4 | Female contact pin | Phosphor Copper | Gold pated | pc | 7 |
| 3 | E13 Hole type socket shell (7 croe) | Nylon | / | pc | 1 |
| 2 | E13 Insulator O ring $\phi 14 \times \phi 11 \times 1.5$ | NBR | / | pc | 1 |
| 1 | E13 Thread type Connecting nut | Nylon | / | pc | 1 |

| Technical specifications: | | Materials: | |
|---------------------------|---------------------|-------------------|--------------------|
| Coupling: | Threaded connection | Shell material: | PA66+GF UL94 black |
| Termination: | Soldering | Contact material: | Brass Gold plated |
| Pollution degree: | 3 | Insert material: | PA66+GF UL94 black |
| Temperature range: | -45°C ~ +105°C | Sealing: | NBR |
| Degree of protection: | IP67 | | |
| Mating cycles: | ≥500 | | |
| Rated voltage: | 60V AC/DC | | |
| Rated current: | 5A | | |

All s are RoHS compliant

| | | |
|---|------|------------|
| GENERAL TOLERANCE (UNLESS SPECIFIED) | DWN | DATE |
| | L.L | 2022.11.12 |
| | CHK | DATE |
| ≤10 ±0.1 <10~≤20 ±0.2 <20~≤50 ±0.5 Angle ±1° | APVD | DATE |
| | UNIT | REV |
| THIRD ANGLE | MM | A |
| | SIZE | SHEET |
| | A4 | 1 OF 1 |



| | |
|------------|------------------|
| TITLE | |
| PART NO | E13001-07A000000 |
| DRAWING NO | E13P-TA1-S7 |