

Rev.	Change Description	ECN #	Date

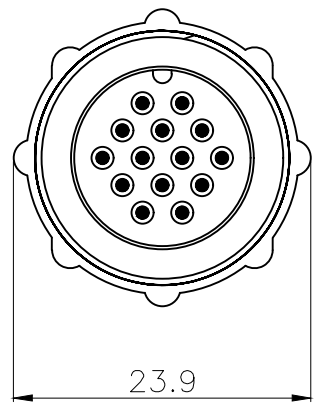

A →

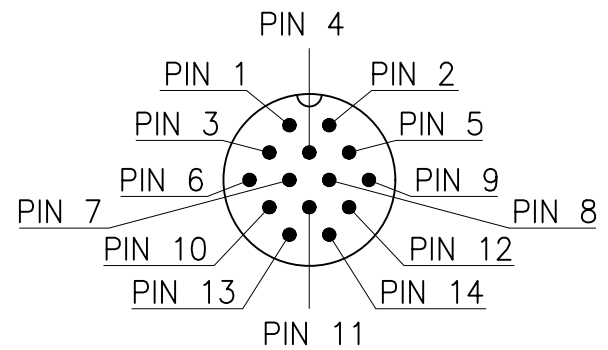
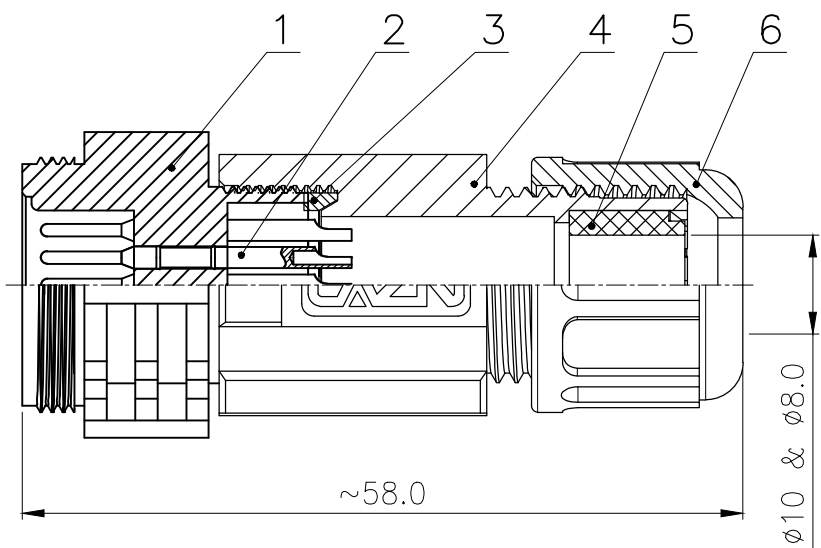

VIEW A

No.	Specification	Material	Treat	Unit	Q'ty
6	Line lock nut	Nylon	/	pc	1
5	Assembled waterproof rubber plug	silica gel	/	pc	1
4	E13 Plug type body	Nylon	/	pc	1
3	E13 Assembly type body waterproof gasket	NBR	/	pc	1
2	Male contact pin	Brass	Gold plated	pc	14
1	E13 Threaded needle type docking plug housing (14 core)	Nylon	/	pc	1

Technical specifications:		Materials:	
Coupling:	Threaded connection	Shell material:	PA66+GF UL94 black
Termination:	Soldering	Contact material:	Brass Gold plated
Pollution degree:	3	Insert material:	PA66+GF UL94 black
Temperature range:	-45°C ~ +105°C	Sealing:	NBR
Degree of protection:	IP67		
Mating cycles:	≥500		
Rated voltage:	60V AC/DC		
Rated current:	5A		
All parts are RoHS compliant			

GENERAL TOLERANCE (UNLESS SPECIFIED)	DWN	DATE	
	L.L	2022.11.12	
	CHK	DATE	
≤10 ±0.1	APVD	DATE	TITLE E13 Straight Male Field Installable Mating Plug 14 Core
<10~≤20 ±0.2			
<20~≤50 ±0.5			
Angle ±1°			
 THIRD ANGLE	UNIT	REV	PART NO
	MM	A	E13004-14A000000
	SIZE	SHEET	DRAWING NO
A4	1 OF 1	E13P-TK1-P14	