

芯位排布

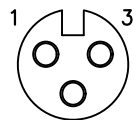

2P



3P

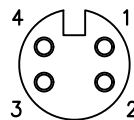

4P

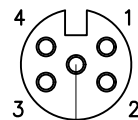

5P

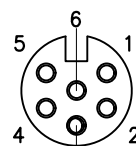

6P

芯数

2

3

4

5

6

额定电压

125V

125V

60V

60V

60V

额定电流

5V

5V

2V

2V

2V

防水等级

IP67/IP68

使用温度

-45~105°C

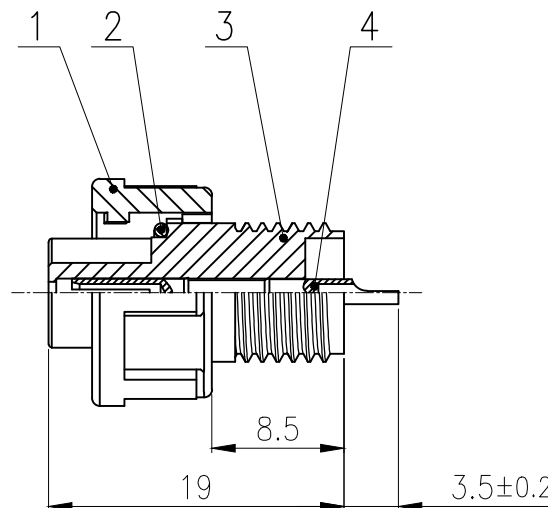
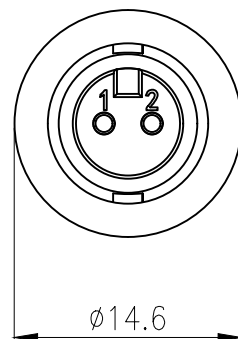

E系列 插针:

2~3P: E系列 1.0焊线式母针短针

4~6P: E系列 0.8焊线式母针短针

GENERAL TOLERANCE (UNLESS SPECIFIED)

≤10 ±0.1

<10~≤20 ±0.2

<20~≤50 ±0.5

Angle ±3°

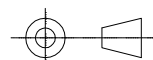

THIRD ANGLE

DWN

DATE

L.L

2022.11.15

CHK

DATE

APVD

DATE

UNIT

MM

REV

A

SIZE

A4

SHEET

1 OF 1

TITLE

E7 卡扣式孔型插头半成品

PART NO

DRAWING NO

E7P-BA1-Sx

CAZN 正成

4	E系列 焊线式母针短针	黄铜	镀金	pc	2~6
3	E7 孔型插头外壳	尼龙	/	pc	1
2	E7 插头胶芯0型防水圈 $\phi 8 \times \phi 6 \times 1$	橡胶	/	pc	1
1	E7 卡扣式连接螺帽	尼龙	/	pc	1
No.	Specification	Material	Treat	Unit	Q'ty