

芯位排布

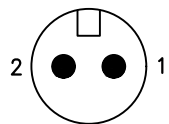

2P

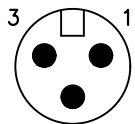

3P

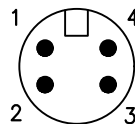

4P

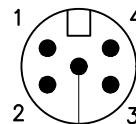

5P

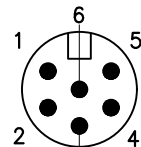

6P

芯数

2

3

4

5

6

额定电压

125V

125V

60V

60V

60V

额定电流

5V

5V

2V

2V

2V

防水等级

IP67/IP68

使用温度

-45~105°C

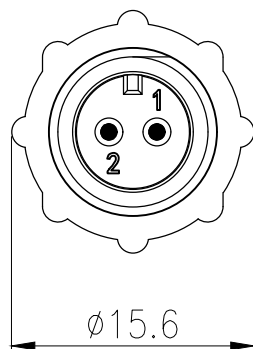
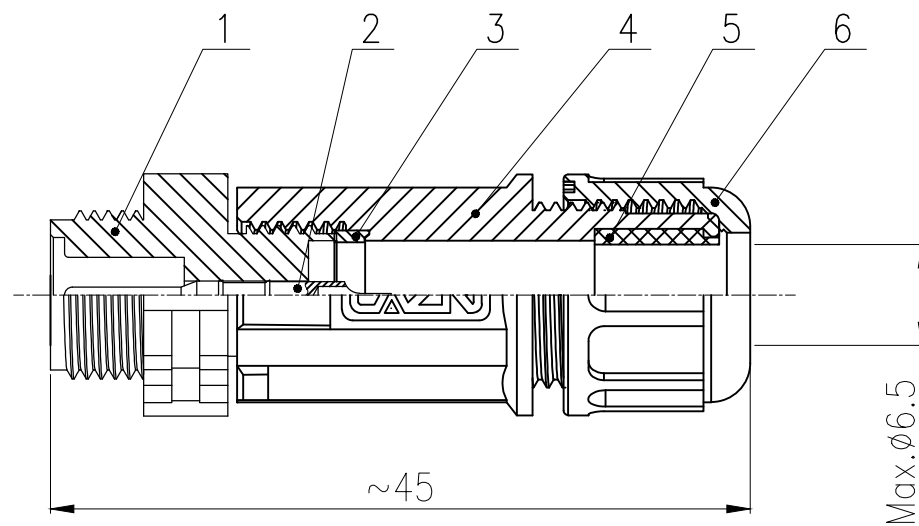

 $\phi 15.6$ 

E系列 插针:

2~3P: E系列 1.0焊线式公针短针

4~6P: E系列 0.8焊线式公针短针

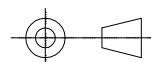
6	E7 紧锁螺帽	尼龙	/	pc	1
5	E10 组装式防水硅胶塞	硅胶	/	pc	1
4	E7 插头主体	尼龙	/	pc	1
3	E7 组装式主体防水垫片 $\phi 8.3 \times \phi 6.5-2$	橡胶	/	pc	1
2	E系列 焊线式公针短针	黄铜	镀金	pc	2~6
1	E7 螺纹式对接针型插头外壳	尼龙	/	pc	1
No.	Specification	Material	Treat	Unit	Q'ty

GENERAL TOLERANCE  
(UNLESS SPECIFIED)
 $\leq 10 \pm 0.1$ 
 $< 10 \sim \leq 20 \pm 0.2$ 
 $< 20 \sim \leq 50 \pm 0.5$ 
Angle  $\pm 3^\circ$ 

THIRD ANGLE

DWN

DATE

L.L

2023.3.29

CHK

DATE

APVD

DATE

UNIT

REV

MM

A

SIZE

SHEET

A4

1 OF 1

TITLE

E7 螺纹式对接针型组装式插头

PART NO

DRAWING NO

E7P-TK-Px