

No.	Specification	Material	Treat	Unit	Q'ty	No.	Specification	Material	Treat	Unit	Q'ty
1	M12 solder wire female pin	Phosphor Copper	Gold plated	pc	8	9	M12 X-type assembled curved body	Zinc alloy	nickel plated	pc	1
2	M12 female head damping connecting screw	Zinc alloy	nickel plated	pc	1	10	Shield ring	Brass	nickel plated	pc	1
3	M12 female head rubber core O-ring	NBR	/	pc	1	11	waterproof O-ring	The Silicone	/	pc	1
4	M12 short body masterbatch core	Nylon	/	pc	1	12	Lock line, tail	Nylon	/	pc	1
5	M12 X-type assembled wave gasket with dots	Manganese Steel	nickel plated	pc	1	13	Waterproof rubber plug	The silicone	/	pc	1
6	M12 metal assembly connection sleeve	Brass	nickel plated	pc	1	14	Line lock nut	Zinc alloy	nickel plated	pc	1
7	M12 main body connecting nut	Brass	nickel plated	pc	1						
8	M12 X type waterproof silicone gasket	The Silicone	/	pc	1						

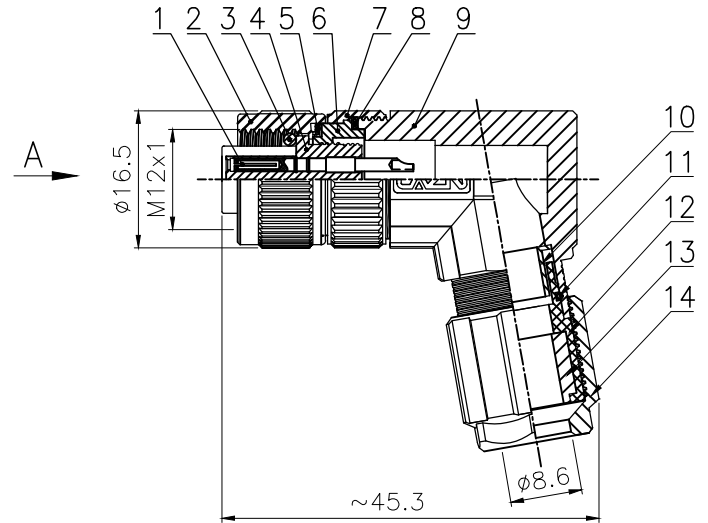
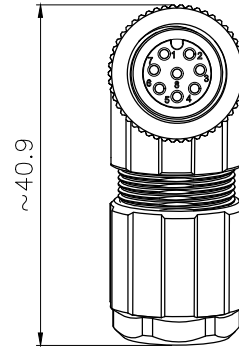
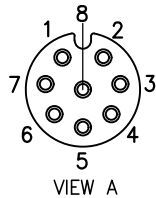
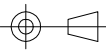

Technical specifications:		Materials:	
Coupling:	Threaded coupling	Shell material:	Brass nickel plated
Termination:	Soldering	Contact material:	Phosphor Copper Gold plated
Coding:	A	Insert material:	PA66+GF UL94 black
Pollution degree:	3	Sealing:	NBR
Temperature range:	-40°C ~ +80°C		
Degree of protection:	IP67		
Mating cycles:	≥500		
Rated voltage:	30V AC/DC		
Rated current:	2A		
Contact resistance:	≤5 mΩ		
Insulation resistance:	≥100 MΩ		
All materials are RoHS compliant			

GENERAL TOLERANCE (UNLESS SPECIFIED) ≤10 ±0.1 <10~≤20 ±0.2 <20~≤50 ±0.5 Angle ±1°	DWN	DATE	CAZN 正成
	W.M	2022.8.22	
	CHK	DATE	
 THIRD ANGLE	APVD	DATE	TITLE M12 Angled Female Metal Plug 8 core
	UNIT	REV	PART NO
	MM	A	120011-08A00000
SIZE	SHEET	DRAWING NO	
A4	1 OF 1	M12G-D1-S8	