

No.	Specification	Material	Treat	Unit	Q'ty	No.	Specification	Material	Treat	Unit	Q'ty
1	M12 塑料组装式马蹄针公针	黄铜	镀金	pc	2~8	7	锁线螺钉 M2X0.45	黄铜	镀镍	pc	2~8
2	M12 锌合金带六角连接螺钉	锌合金	镀镍	pc	1	8	M12 塑料组装式 1.0马蹄针保护套	尼龙	/	pc	1
3	M12 塑料组装式公胶芯	尼龙	/	pc	1	9	防水硅胶塞 PG7规格	硅胶	/	pc	1
4	防水密封O型圈 $\phi 15 \times \phi 12.6 \times 1.2$	橡胶	/	pc	1	10	锁线尾爪 PG7规格	尼龙	/	pc	1
5	M12 主体连接螺帽	尼龙	/	pc	1	11	尾线螺母 PG7规格	尼龙	/	pc	1
6	M12 塑料组装式弯式主体 PG7规格	尼龙	/	pc	1						

芯位排布

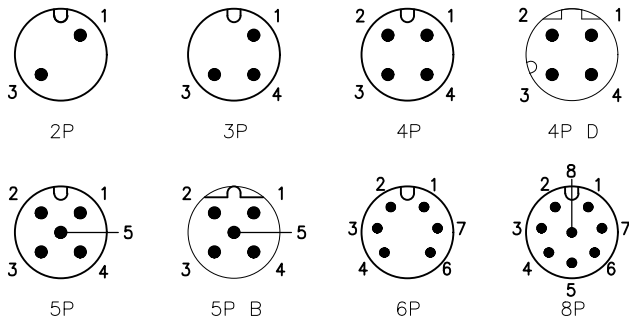

技术参数

连接方式: 螺纹连接
 接线方式: 螺钉压接
 污染等级: 3
 温度范围: $-40^{\circ}\text{C} \sim +80^{\circ}\text{C}$
 防护等级: IP67
 插拔周期: ≥ 500

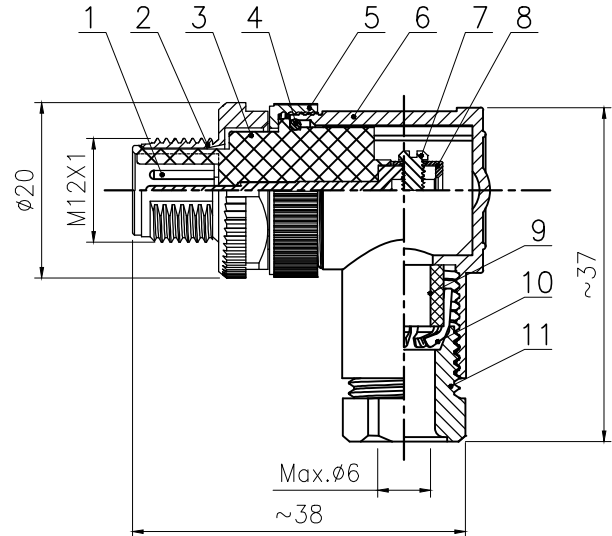
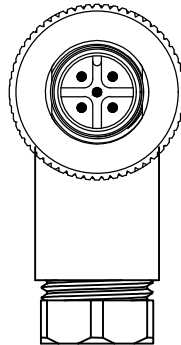

芯数	2	3	4	4D	5	5B	6	8
额定电流/电压	4A/250V	4A/250V	4A/250V	4A/250V	4A/60V	4A/60V	2A/30V	2A/30V
额定脉冲电压	2500V	2500V	2500V	2500V	1500V	1500V	800V	800V
绝缘电阻 (M Ω)	≥ 100	≥ 100	≥ 100	≥ 100	≥ 100	≥ 100	≥ 100	≥ 100
接触电阻 (m Ω)	≤ 5	≤ 5	≤ 5	≤ 5	≤ 5	≤ 5	≤ 5	≤ 5

GENERAL TOLERANCE
 (UNLESS SPECIFIED)
 $\leq 10 \pm 0.1$
 $< 10 \sim \leq 20 \pm 0.2$
 $< 20 \sim \leq 50 \pm 0.5$
 Angle $\pm 1^{\circ}$

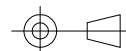

THIRD ANGLE

DWN	DATE
W.M	2022.8.19
CHK	DATE
APVD	DATE
UNIT	REV
MM	A
SIZE	SHEET
A4	1 OF 1

CAZN 正成

TITLE
M12 塑料弯式针型组装式插头 PG7规格

PART NO
DRAWING NO
M12P-D1-Px-PG7