

Rev.	Change Description	ECN #	Date

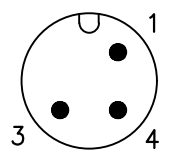

VIEW A

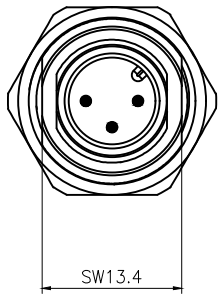

SW13.4

A

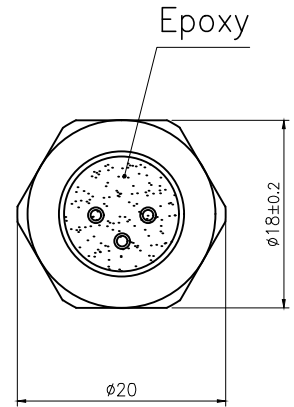
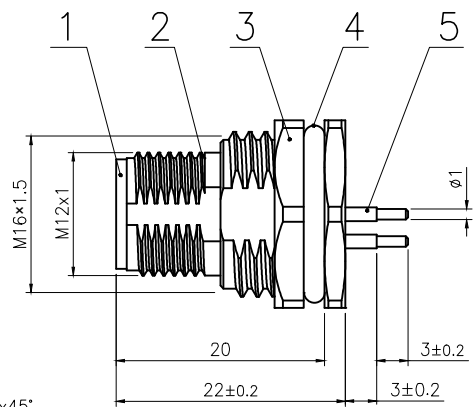

Epoxy

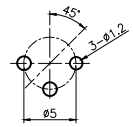

RECOMMENDED P.C.B LAYOUT

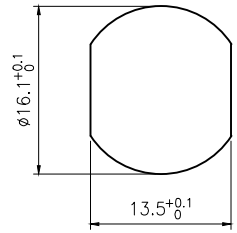

BOARD END HOLE OPENING SIZE

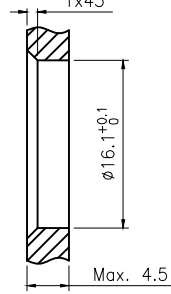

Technical specifications:		Materials:	
Coupling:	Threaded coupling	Shell material:	Brass/Zinc alloy nickel plated
Termination:	Dip solder	Contact material:	Brass Gold plated
Coding:	A	Insert material:	PA66+GF UL94 black
Pollution degree:	3	Sealing:	Fluro rubber,Green
Temperature range:	-40°C ~ +80°C		
Degree of protection:	IP67		
Mating cycles:	≥500		
Rated voltage:	250V AC/DC		
Rated current:	4A		
Contact resistance:	≤5 mΩ		
Insulation resistance:	≥100 MΩ		

All materials are RoHS compliant

5	M12 Male contact pin Gold plated OD:1.0	pc	3
4	Fluro rubber φ16*φ12*2 Green	pc	1
3	Hexagon nut Brass φ20*φ18-2.8 M16*1.5 thread, single chamfer (M12 seat nut) bright nickel	pc	1
2	M12 threaded plate back male zinc alloy shell lock plate screw M16*1.5	pc	1
1	M12 A code male type long Rubber core PA66 material 3 core black	pc	1
No.	Specification	Unit	Q'ty

GENERAL TOLERANCE (UNLESS SPECIFIED)	DWN	DATE	
	W.M	2023.8.14	
	CHK	DATE	
≤10 ±0.1	APVD	DATE	TITLE
<10~≤20 ±0.2			M12 Male Back Mount Socket 3 core
<20~≤50 ±0.5			
Angle ±1°			
 THIRD ANGLE	UNIT	REV	PART NO
	MM	A	C110204-00323
	SIZE	SHEET	DRAWING NO
	A4	1 OF 1	M12-P3A-GPFM16-ZA