

Rev.	Change Description	ECN #	Date

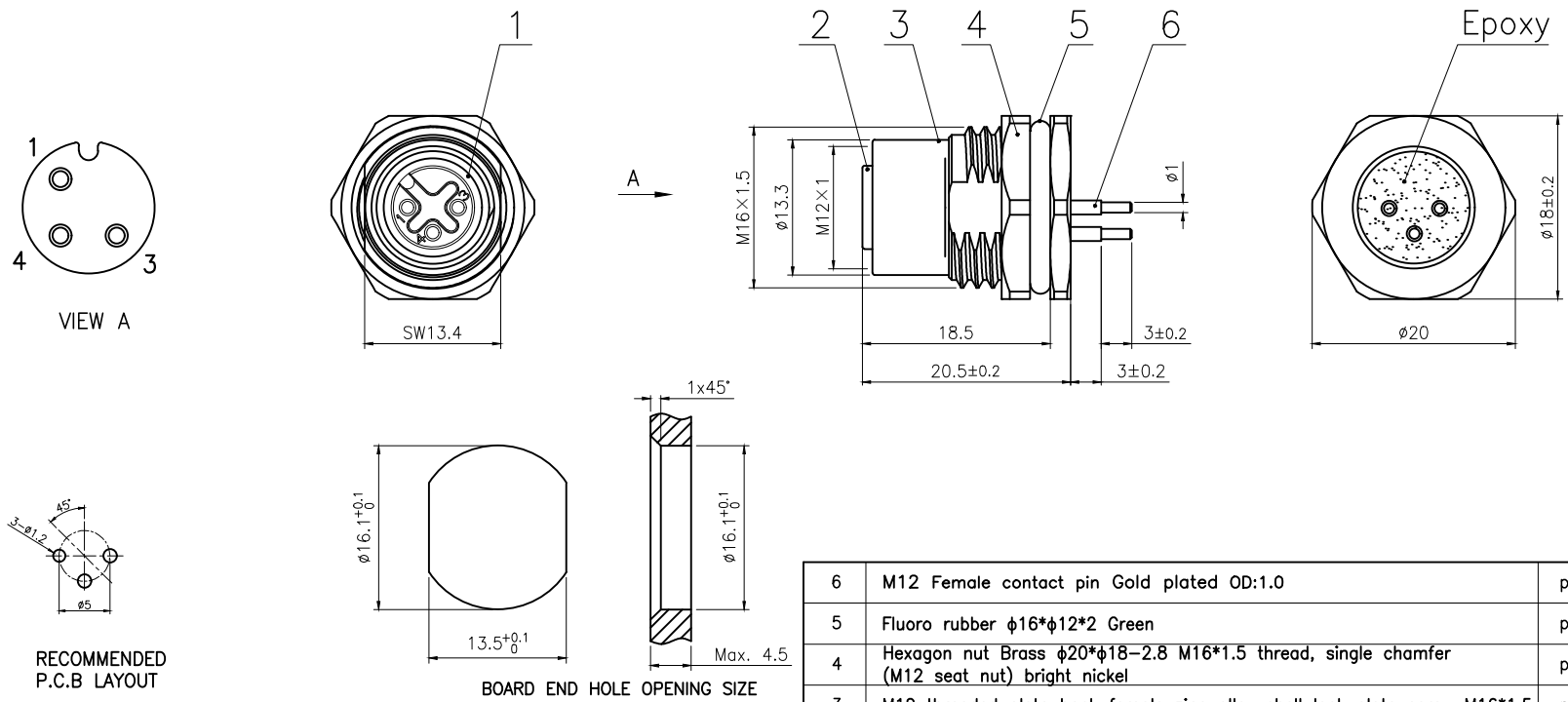

6	M12 Female contact pin Gold plated OD:1.0	pc	3
5	Fluoro rubber $\phi 16 \times \phi 12 \times 2$ Green	pc	1
4	Hexagon nut Brass $\phi 20 \times \phi 18 - 2.8$ M16*1.5 thread, single chamfer (M12 seat nut) bright nickel	pc	1
3	M12 threaded plate back female zinc alloy shell lock plate screw M16*1.5	pc	1
2	M12 A code female type long Rubber core PA66 material 3 core black	pc	1
1	Fluoro rubber $\phi 9 \times \phi 6 \times 1.5$ Green	pc	1
No.	Specification	Unit	Q'ty

Technical specifications:		Materials:	
Coupling:	Threaded coupling	Shell material:	Brass/Zinc alloy nickel plated
Termination:	Dip solder	Contact material:	Phosphor Copper Gold plated
Coding:	A	Insert material:	PA66+GF UL94 black
Pollution degree:	3	Sealing:	Fluoro rubber, Green
Temperature range:	-40°C ~ +80°C		
Degree of protection:	IP67		
Mating cycles:	≥500		
Rated voltage:	250V AC/DC		
Rated current:	4A		
Contact resistance:	≤5 mΩ		
Insulation resistance:	≥100 MΩ		

All materials are RoHS compliant

GENERAL TOLERANCE (UNLESS SPECIFIED)	DWN	DATE	
	W.M	2023.8.14	
	CHK	DATE	
≤10 ±0.1	APVD	DATE	TITLE
<10~≤20 ±0.2			M12 Female Back Mount Socket 3 core
<20~≤50 ±0.5			
Angle ±1°			
 THIRD ANGLE	UNIT	REV	PART NO
	MM	A	C110204-00335
	SIZE	SHEET	DRAWING NO
	A4	1 OF 1	M12-S3A-GPFM16-ZA