

Rev.	Change Description	ECN #	Date

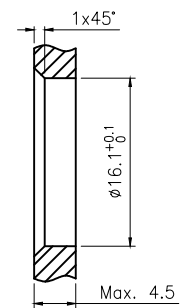
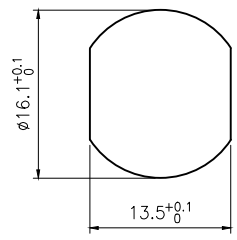
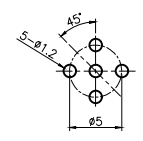
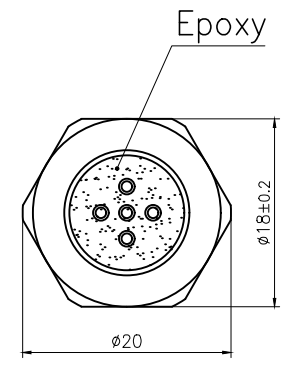
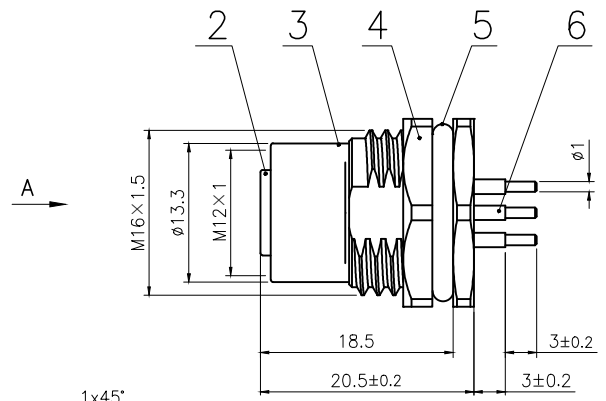
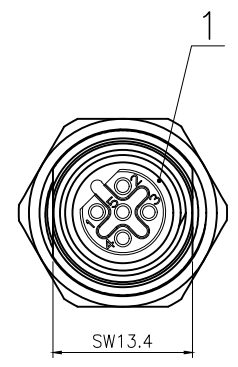
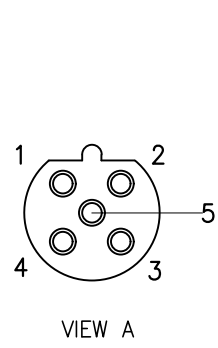

BOARD END HOLE OPENING SIZE

6	M12 Female contact pin Gold plated OD:1.0	pc	5
5	Fluoro rubber $\phi 16*\phi 12*2$ Green	pc	1
4	Hexagon nut Brass $\phi 20*\phi 18-2.8$ M16*1.5 thread, single chamfer (M12 seat nut) bright nickel	pc	1
3	M12 threaded plate back female zinc alloy shell lock plate screw M16*1.5	pc	1
2	M12 B code female type long Rubber core PA66 material 5 core black	pc	1
1	Fluoro rubber $\phi 9*\phi 6*1.5$ Green	pc	1
No.	Specification	Unit	Q'ty

Technical specifications:		Materials:	
Coupling:	Threaded coupling	Shell material:	Brass/Zinc alloy nickel plated
Termination:	Dip solder	Contact material:	Phosphor Copper Gold plated
Coding:	B	Insert material:	PA66+GF UL94 black
Pollution degree:	3	Sealing:	Fluoro rubber, Green
Temperature range:	-40°C ~ +80°C		
Degree of protection:	IP67		
Mating cycles:	≥500		
Rated voltage:	60V AC/DC		
Rated current:	4A		
Contact resistance:	≤5 mΩ		
Insulation resistance:	≥100 MΩ		

All materials are RoHS compliant

GENERAL TOLERANCE (UNLESS SPECIFIED)	DWN	DATE	
	W.M	2023.8.14	
	CHK	DATE	
≤10 ±0.1	APVD	DATE	TITLE
<math><10\sim\le 20</math> ±0.2	UNIT	REV	PART NO
<math><20\sim\le 50</math> ±0.5	MM	A	C110204-00340
Angle ±1°	SIZE	SHEET	DRAWING NO
	A4	1 OF 1	M12-S5B-GPFM16-ZA

