

Rev.	Change Description	ECN #	Date

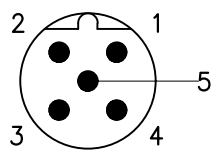

VIEW A

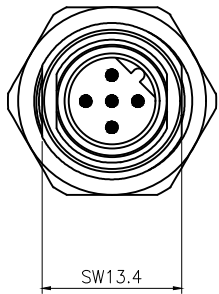

SW13.4

A →

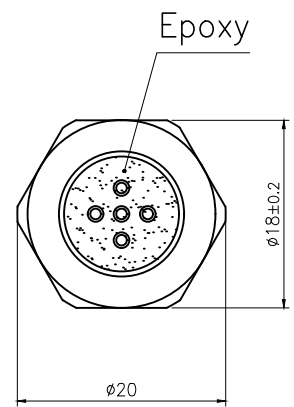
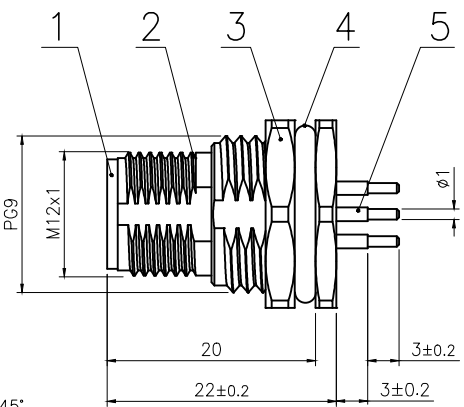

Epoxy

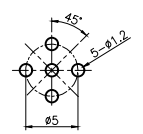

RECOMMENDED P.C.B LAYOUT

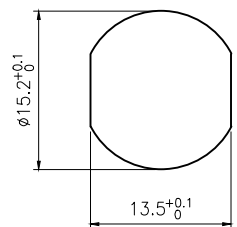

BOARD END HOLE OPENING SIZE

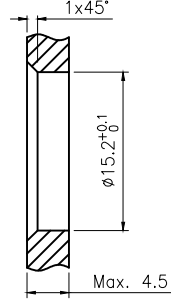

Technical specifications:		Materials:	
Coupling:	Threaded coupling	Shell material:	Brass/Zinc alloy nickel plated
Termination:	Dip solder	Contact material:	Brass Gold plated
Coding:	B	Insert material:	PA66+GF UL94 black
Pollution degree:	3	Sealing:	Fluoro rubber,Green
Temperature range:	-40°C ~ +80°C		
Degree of protection:	IP67		
Mating cycles:	≥500		
Rated voltage:	60V AC/DC		
Rated current:	4A		
Contact resistance:	≤5 mΩ		
Insulation resistance:	≥100 MΩ		
All materials are RoHS compliant			

5	M12 Male contact pin Gold plated OD:1.0	pc	5
4	Fluoro rubber φ16*φ12*2 Green	pc	1
3	Hexagon nut Brass φ20*φ18-2.8 PG9 thread, single chamfer (M12 seat nut) bright nickel	pc	1
2	M12 threaded plate back male zinc alloy shell lock plate screw PG9	pc	1
1	M12 B code male type long Rubber core PA66 material 5 core black	pc	1
No.	Specification	Unit	Q'ty

GENERAL TOLERANCE (UNLESS SPECIFIED)	DWN	DATE	
	W.M	2023.8.14	
	CHK	DATE	
≤10 ±0.1	APVD	DATE	TITLE
<10~≤20 ±0.2	UNIT	REV	M12 Male Back Mount Socket 5 core B code
<20~≤50 ±0.5	MM	A	PART NO
Angle ±1°	SIZE	SHEET	C110204-00352
	A4	1 OF 1	DRAWING NO
			M12-P5B-GFPF9-ZA

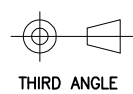

THIRD ANGLE