

No.	Specification	Material	Treat	Unit	Q'ty	No.	Specification	Material	Treat	Unit	Q'ty
1	M40 8芯胶芯前盖	尼龙	/	pc	1	8	屏蔽环	黄铜	镀镍	pc	1
2	M40 内螺牙连接套	黄铜	镀镍	pc	1	9	防水O型圈	橡胶	/	pc	1
3	M40 连接套卡簧	紫铜	镀镍	pc	1	10	锁线网尾套	尼龙	/	pc	1
4	M40 胶芯塑胶套	塑胶	/	pc	1	11	防水硅胶塞	硅胶	/	pc	1
5	M40 3.6/2.0 铆压母针	黄铜	镀金	pc	4/4	12	紧锁螺帽	黄铜	镀镍	pc	1
6	M40 针体支架	塑胶	/	pc	1						
7	M40 直式主体	锌合金	镀镍	pc	1						

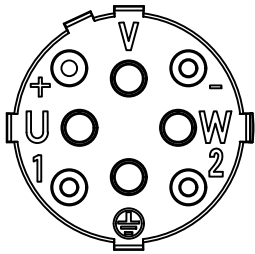

芯位排布

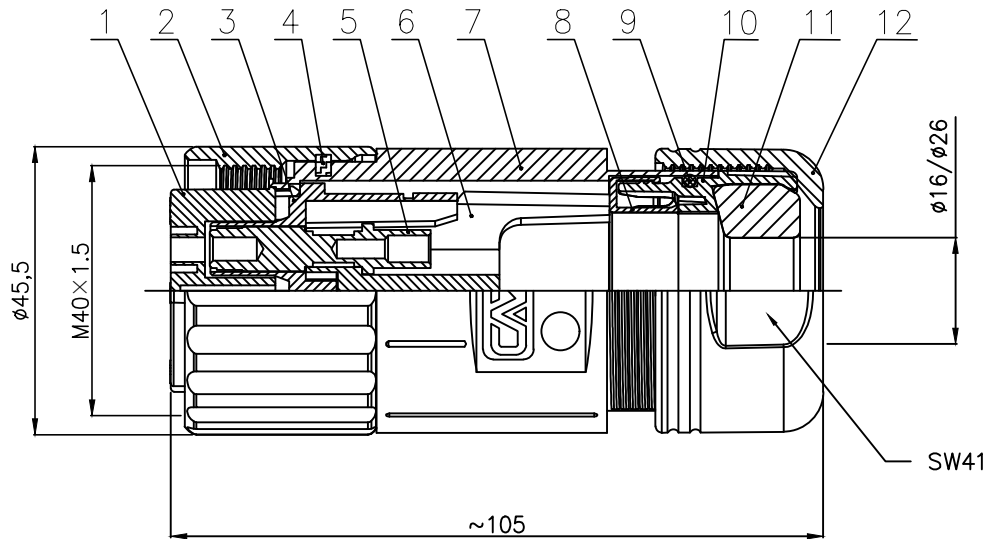
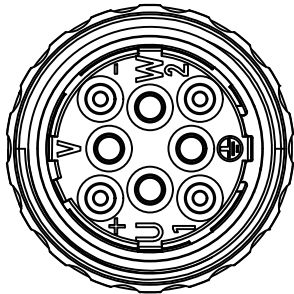

技术参数		材料	
连接方式:	螺纹连接	外壳材料:	锌合金, 镀镍
接线方式:	压接	接触体材料:	黄铜, 镀金
编 码:		绝缘体材料:	PA66 UL 94-V0
污染等级:	3	密封材料:	橡胶, 黑色
温度范围:	-40°C ~ +130°C		
防护等级:	IP67		
插拔周期:	≥50		
额定电压:	630V/250V AC/DC		
额定电流:	70A/30A		
接触电阻:	≤1 mΩ		
绝缘电阻:	≥100 MΩ		
所有材料均符合RoHS要求			

GENERAL TOLERANCE (UNLESS SPECIFIED) ≤10 ±0.1 <10~≤20 ±0.2 <20~≤50 ±0.5 Angle ±1°	DWN		
	CHK		
	APVD		
 THIRD ANGLE	UNIT	REV	TITLE
	MM	A	M40 直式孔型金属插头 8芯
	SIZE	SHEET	PART NO
A4	1 OF 1	DRAWING NO	M40G-A-S8